

TAMRON

Focus on the Future



6MP – M17FM-RG SERIES

PIXEL PITCH
2.4 μm

1/1.7"
IMAGERS

RUGGED LENS DESIGN

TAMRON'S SUPER COMPACT LENS SERIES



FOCUS ON THE FUTURE

With 70 years of expertise, Tamron stands as a renowned leader in optical technology. Our commitment to innovation and precision ensures that our products deliver reliable, high-performance lenses designed to meet the specific demands of machine vision applications. Crafted with meticulous attention to detail, our lenses guarantee superior performance and reliability across diverse industrial applications.

HIGHLIGHTS OF THE M117FM-RG SERIES



- Ruggedized
- Industry leading low distortion
- High quality performance at close up distances
- 6MP with 1/1.7" or 1/1.8" sensors
- Great cost performance ratio
- Compact and uniform lens design

M117FM06-RG

STANDARD LINE

RUGGEDIZED AND COMPACT

PIXEL PITCH
2.4 μm

1/1.7"
IMAGERS

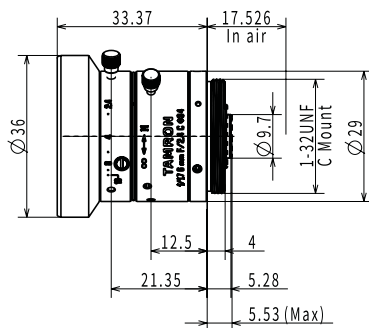

- Focal length 6 mm
- Aperture F/2.4 ~ F/16
- Filter size M34 P = 0.5 mm
- Exit Pupil Position -44.9 mm
- TV Distortion -1.02%
- M.O.D. 100 mm
- Max. Diameter 36.0 mm
- Weight 50 g
- Operating Temp. -20°C ~ +60°C

Angle of
View

1/1.7"	65.0° x 50.5°
1/1.8"	64.2° x 44.9°
1/2"	56.5° x 43.4°
1/3"	43.4° x 32.9°

MTF Curves

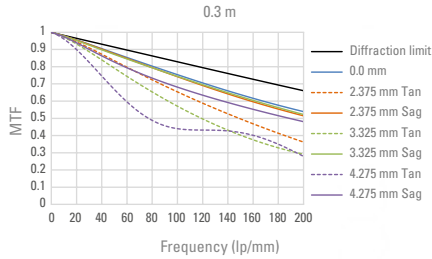

Transmittance of Wavelengths

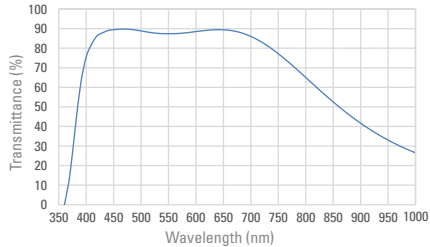

Relative Illumination on Image Circle

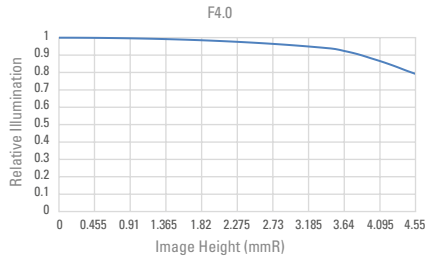

This table shows the shooting distance and coverage by using different extension rings (Imager Size: 1/1.7")

Size of Extension Ring	M117FM06 (f=06/F2.4)	
	WD	Coverage
W/O	1000.0	1287.5 x 951.4
	100.0	139.7 x 102.9
0.5	68.4	90.3 x 66.5
	37.2	57.6 x 42.3
1	30.3	47.1 x 34.5
	20.5	36.5 x 26.7
1.5	17.7	32.0 x 23.4
	12.9	26.7 x 19.5
5	—	—
10	—	—
15	—	—
20	—	—
25	—	—
30	—	—
35	—	—
40	—	—

Upper column: Data at the infinity focusing position.
(In W/O, data at 1.0m focusing position)

Lower column: Data at the nearest focusing position

Taking distance: From barrel top to the object

MTF Curves

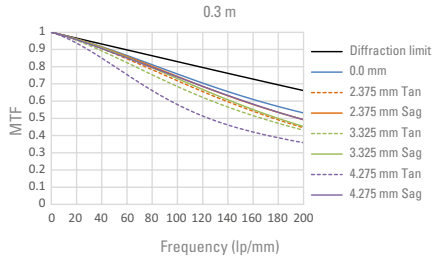

Transmittance of Wavelengths

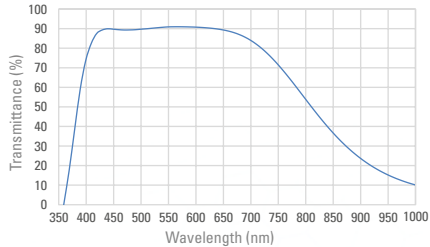

Relative Illumination on Image Circle

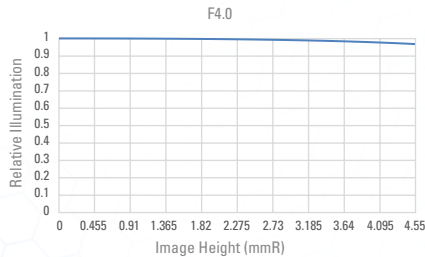

This table shows the shooting distance and coverage by using different extension rings (Imager Size: 1/1.7")

Size of Extension Ring	M117FM08 (f=8/F2.4)	
	WD	Coverage
W/O	1000.0	976.4 × 725.2
	100.0	105.6 × 78.2
0.5	117.5	123.0 × 91.2
	49.8	57.1 × 42.2
1	54.2	61.8 × 45.7
	31.3	39.3 × 29.0
1.5	33.1	41.3 × 30.5
	21.7	29.9 × 22.1
5	3.6	12.7 × 9.3
	2.6	11.4 × 8.3
10	—	—
15	—	—
20	—	—
25	—	—
30	—	—
35	—	—
40	—	—

Upper column: Data at the infinity focusing position.
(In W/O, data at 1.0m focusing position)

Lower column: Data at the nearest focusing position

Taking distance: From barrel top to the object

M117FM00-RG

STANDARD LINE

RUGGEDIZED AND COMPACT

PIXEL PITCH
2.4 μ m

1/1.7"
IMAGERS

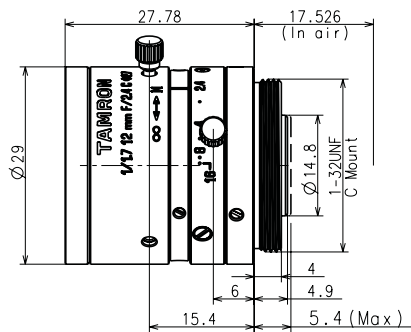

- Focal length 12 mm
- Aperture F/2.4 ~ F/16
- Filter size M27 P=0.5mm
- Exit Pupil Position -40.1 m
- TV Distortion -0.42 %
- M.O.D. 100 mm
- Max. Diameter 29.0 mm
- Weight 40 g
- Operating Temp. -20°C ~ +60°C

Angle of
View

1/1.7"	34.3° x 25.9°
1/1.8"	33.7° x 22.9°
1/2"	29.3° x 22.1°
1/3"	22.1° x 16.6°

MTF Curves

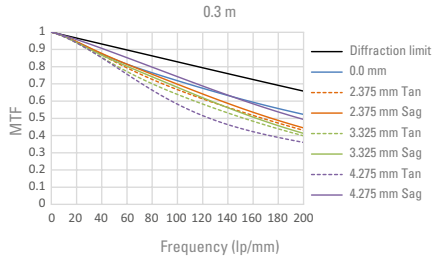

Transmittance of Wavelengths

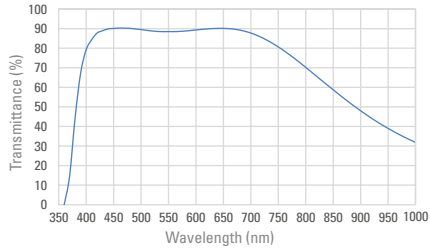

Relative Illumination on Image Circle

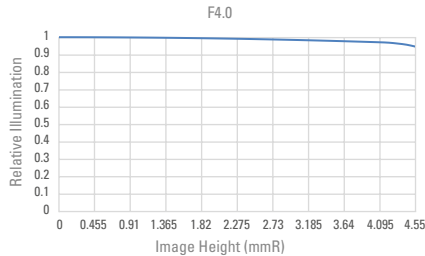

This table shows the shooting distance and coverage by using different extension rings (Imager Size: 1/1.7")

Size of Extension Ring	M117FM12 (f=12/F2.4)	
	WD	Coverage
W/O	1000.0	623.2 × 465.4
	100.0	68.4 × 51.0
0.5	296.0	143.9 × 107.4
	74.1	50.2 × 37.4
1	144.3	81.6 × 60.8
	57.0	39.7 × 29.5
1.5	94.1	57.0 × 42.4
	45.9	32.9 × 24.4
5	23.5	18.5 × 13.7
	17.0	15.0 × 11.1
10	8.4	9.5 × 7.0
	6.6	8.5 × 6.3
15	–	–
20	–	–
25	–	–
30	–	–
35	–	–
40	–	–

Upper column: Data at the infinity focusing position.
(In W/O, data at 1.0m focusing position)

Lower column: Data at the nearest focusing position

Taking distance: From barrel top to the object

MTF Curves

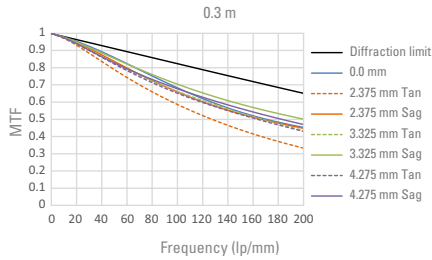

Transmittance of Wavelengths

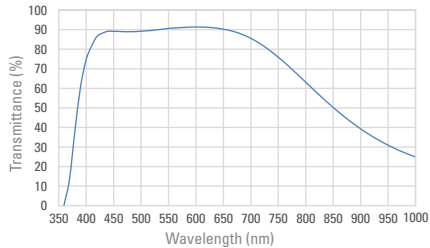

Relative Illumination on Image Circle

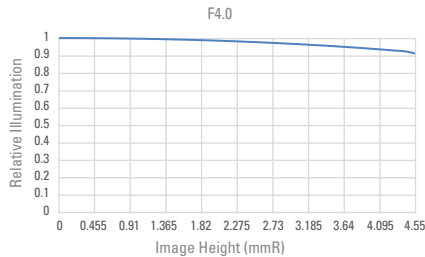

This table shows the shooting distance and coverage by using different extension rings (Imager Size: 1/1.7")

Size of Extension Ring	M117FM16 (f=16/F2.4)	
	WD	Coverage
W/O	1000.0	463.8 x 347.5
	100.0	46.3 x 34.7
0.5	535.2	245.0 x 183.5
	96.2	39.3 x 29.4
1	271.4	122.6 x 91.8
	84.4	34.1 x 25.5
1.5	183.4	81.8 x 61.2
	75.4	30.1 x 22.5
5	60.5	24.7 x 18.5
	44.9	16.7 x 12.5
10	34.2	12.5 x 9.3
	30.3	10.2 x 7.6
15	25.4	8.3 x 6.2
	23.9	7.3 x 5.5
20	20.9	6.2 x 4.6
	20.3	5.7 x 4.3
25	—	—
30	—	—
35	—	—
40	—	—

Upper column: Data at the infinity focusing position.
(In W/O, data at 1.0m focusing position)

Lower column: Data at the nearest focusing position

Taking distance: From barrel top to the object

M117FM06-RG

STANDARD LINE

RUGGEDIZED AND COMPACT

PIXEL PITCH
2.4 μ m

1/1.7"
IMAGERS

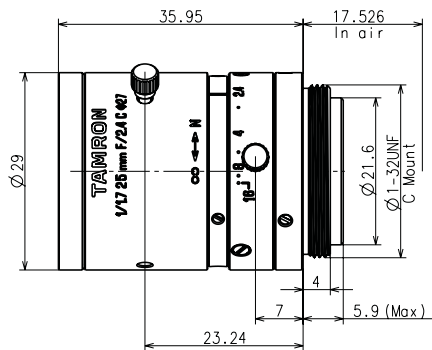

- Focal length 25 mm
- Aperture F/2.4 ~ F/16
- Filter size M27 P = 0.5 mm
- Exit Pupil Position -42.4 m
- TV Distortion -0.10%
- M.O.D. 100 mm
- Max. Diameter 29.0 mm
- Weight 45 g
- Operating Temp. -20°C ~ +60°C

Angle of
View

1/1.7"	17.4° x 13.1°
1/1.8"	17.1° x 11.5°
1/2"	14.8° x 11.2°
1/3"	11.2° x 8.4°

MTF Curves

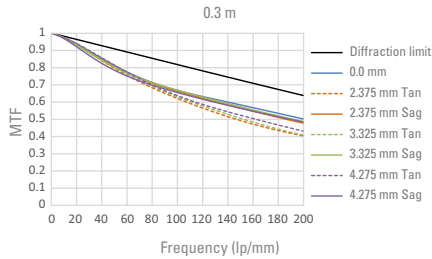

Transmittance of Wavelengths

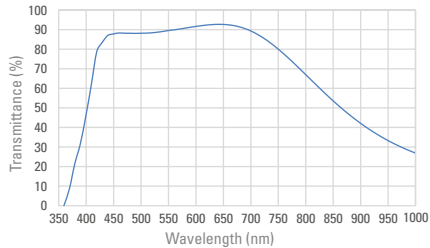

Relative Illumination on Image Circle

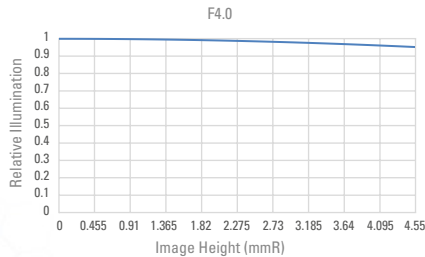

This table shows the shooting distance and coverage by using different extension rings (Imager Size: 1/1.7")

Size of Extension Ring	M117FM25 (f=25/F2.4)	
	WD	Coverage
W/O	1000.0	303.8 × 227.8
	100.0	28.5 × 21.4
0.5	1217.2	369.9 × 277.3
	105.0	26.7 × 20.0
1	610.7	184.4 × 138.3
	99.1	25.1 × 18.8
1.5	410.1	123.1 × 92.3
	93.9	23.7 × 17.7
5	129.0	37.1 × 27.8
	69.2	17.0 × 12.7
10	68.9	18.7 × 14.0
	51.3	12.1 × 9.1
15	48.7	12.5 × 9.3
	41.3	9.4 × 7.0
20	38.5	9.3 × 7.0
	35.1	7.7 × 5.7
25	32.4	7.5 × 5.6
	30.6	6.5 × 4.8
30	28.3	6.2 × 4.6
	27.4	5.6 × 4.2
35	—	—
40	—	—

Upper column: Data at the infinity focusing position.
(In W/O, data at 1.0m focusing position)

Lower column: Data at the nearest focusing position

Taking distance: From barrel top to the object

M117FM06-RG

STANDARD LINE

RUGGEDIZED AND COMPACT

PIXEL PITCH
2.4 μ m

1/1.7"
IMAGERS

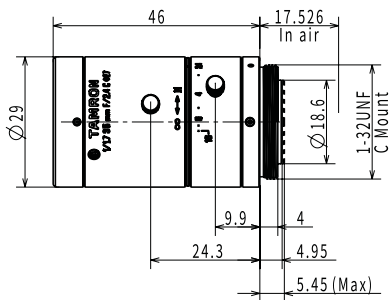

- Focal length 35 mm
- Aperture F/2.4 ~ F/16
- Filter size M27 P = 0.5 mm
- Exit Pupil Position -42.18 mm
- TV Distortion -0.06 %
- M.O.D. 100 mm
- Max. Diameter 29.0 mm
- Weight 65 g
- Operating Temp. -20°C ~ +60°C

Angle of
View

1/1.7"

12.6° x 9.5°

1/1.8"

12.4° x 8.4°

1/2"

10.8° x 8.1°

1/3"

8.1° x 6.1°

MTF Curves

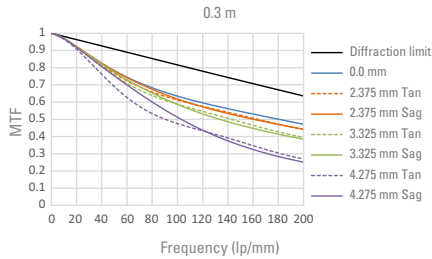

Transmittance of Wavelengths

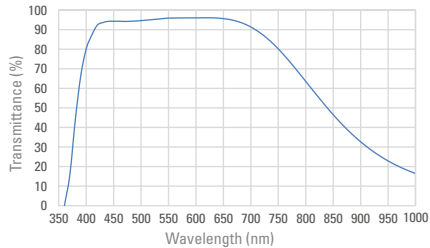

Relative Illumination on Image Circle

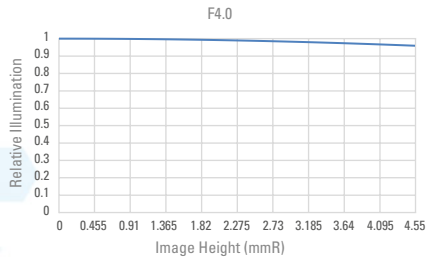

This table shows the shooting distance and coverage by using different extension rings (Imager Size: 1/1.7")

Size of Extension Ring	M117FM35 (f=35/F2.4)	
	WD	Coverage
W/O	1000.0	222.3 x 166.8
	100.0	23.1 x 17.3
0.5	2300.0	510.0 x 382.7
	95.5	22.1 x 16.6
1	1142.0	253.8 x 190.4
	91.4	21.2 x 15.9
1.5	759.5	169.1 x 126.9
	87.6	20.4 x 15.3
5	225.0	50.8 x 38.1
	67.7	15.9 x 11.9
10	110.7	25.5 x 19.1
	50.7	12.2 x 9.1
15	72.6	17.0 x 12.8
	40.3	9.8 x 7.4
20	53.5	12.8 x 9.6
	33.2	8.3 x 6.2
25	42.1	10.2 x 7.7
	28.0	7.1 x 5.3
30	34.4	8.5 x 6.4
	24.1	6.2 x 4.7
35	28.9	7.3 x 5.5
	21.0	5.6 x 4.2
40	24.8	6.4 x 4.8
	18.5	5.0 x 3.8

Upper column: Data at the infinity focusing position.
(In W/O, data at 1.0m focusing position)

Lower column: Data at the nearest focusing position

Taking distance: From barrel top to the object

M117FM00-RG

STANDARD LINE

RUGGIDIZED AND COMPACT

PIXEL PITCH
2.4 μ m

1/1.7"
IMAGERS

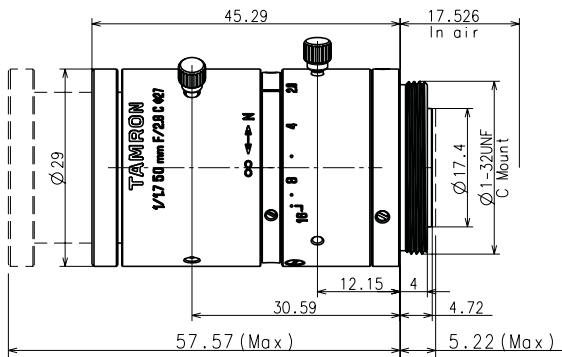

- Focal length 50 mm
- Aperture F/2.8 ~ F/16
- Filter size M27 P = 0.5 mm
- Exit Pupil Position -58.65 m
- TV Distortion -0.01 %
- M.O.D. 200 mm
- Max. Diameter 29.0 mm
- Weight 60 g
- Operating Temp. -20°C ~ +60°C

Angle of
View

1/1.7"

8.9° x 6.7°

1/1.8"

8.7° x 5.9°

1/2"

7.5° x 5.7°

1/3"

5.7° x 4.3°

MTF Curves

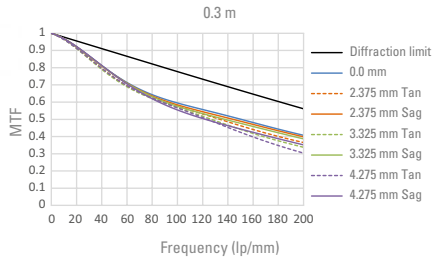

Transmittance of Wavelengths

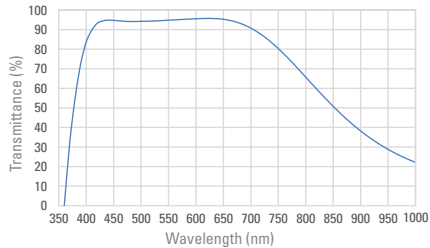

Relative Illumination on Image Circle

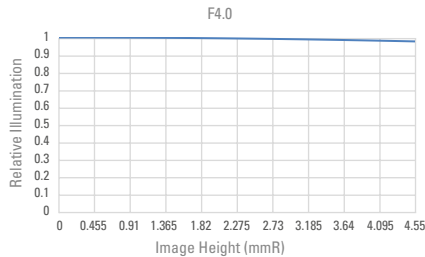

This table shows the shooting distance and coverage by using different extension rings (Imager Size: 1/1.7")

Size of Extension Ring	M117FM50 (f=50/F2.8)	
	WD	Coverage
W/O	1000.0	154.9 x 116.3
	200.0	30.9 x 23.1
0.5	4700.0	728.6 x 546.9
	191.9	29.6 x 22.2
1	2340.0	362.7 x 272.3
	184.5	28.5 x 21.3
1.5	1560.0	241.8 x 181.5
	177.6	27.4 x 20.5
5	468.5	72.5 x 54.4
	141.0	21.7 x 16.3
10	235.2	36.3 x 27.3
	109.1	16.7 x 12.6
15	157.5	24.3 x 18.2
	89.1	13.6 x 10.2
20	118.7	18.2 x 13.7
	75.3	11.5 x 8.6
25	95.3	14.6 x 10.9
	65.1	9.9 x 7.4
30	79.7	12.2 x 9.1
	57.5	8.7 x 6.5
35	68.6	10.4 x 7.8
	51.5	7.8 x 5.8
40	60.2	9.1 x 6.8
	46.8	7.0 x 5.3

Upper column: Data at the infinity focusing position. (In W/O, data at 1.0m focusing position)

Lower column: Data at the nearest focusing position

Taking distance: From barrel top to the object

EXPLANATION

- 1 Model Number, focal length
- 2 Object distance from the tip of the mechanical end at infinity focus
- 3 Size of the extension ring in mm
- 4 Object distance from the tip of the mechanical end at MOD
- 5 Data at infinity focusing position
- 6 Data at the minimum focusing position

1. Please use the data shown here for your reference only, it is not the actual figure.
2. TAMRON will not be responsible for any trouble caused using this figure.
3. This data is a calculated figure, not based on real measurements.
4. Please note that tolerances are not taken into consideration within this calculation.
5. There might be small differences between each piece.
6. There might be some loss in image quality by applying an extension ring.
7. TAMRON does not guarantee the original image performance while using any extension rings.
8. This data is based on all sources available as of June 26, 2017.
9. This data is subject to change without notice.
10. All units are given in mm.



Size of Extension Ring	1 M117FM50 (f=50/F2.8)	
	WD	Coverage
W/O	1000.0 200.0	154.9 x 116.3 30.9 x 23.1
3 0.5	2 4700.0 4 191.9	5 728.6 x 546.9 6 29.6 x 22.2
1	2340.0 184.5	362.7 x 272.3 28.5 x 21.3
1.5	1560.0 177.6	241.8 x 181.5 27.4 x 20.5
5	468.5 141.0	72.5 x 54.4 21.7 x 16.3
10	235.2 109.1	36.3 x 27.3 16.7 x 12.6
15	157.5	24.3 x 18.2

IMAGE CIRCLE

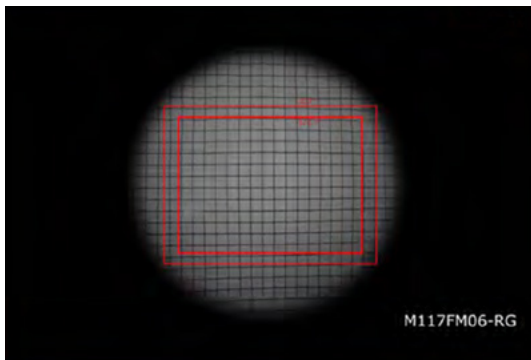

M117FM06-RG on an APS-C sensor

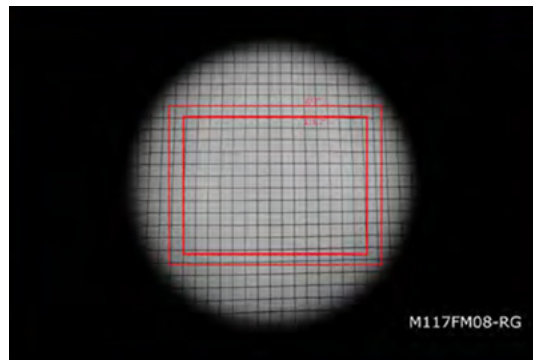

M117FM08-RG on an APS-C sensor

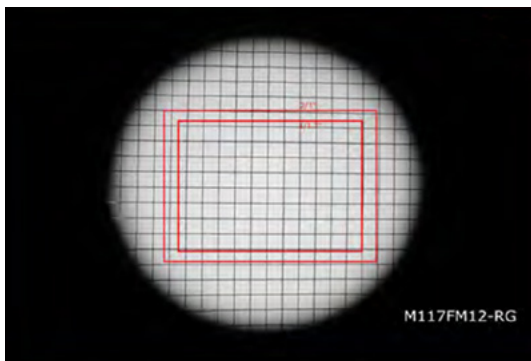

M117FM12-RG on an APS-C sensor

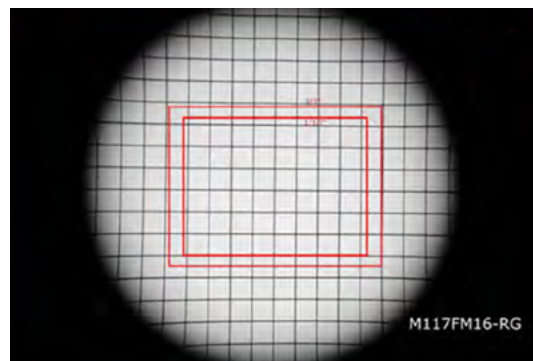

M117FM16-RG on an APS-C sensor

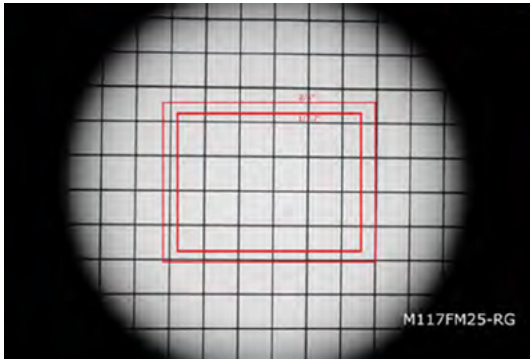

M117FM25-RG on an APS-C sensor

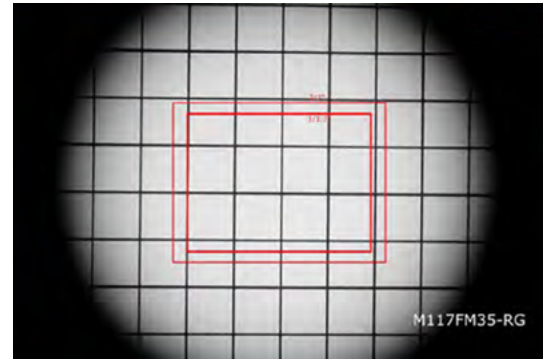

M117FM35-RG on an APS-C sensor

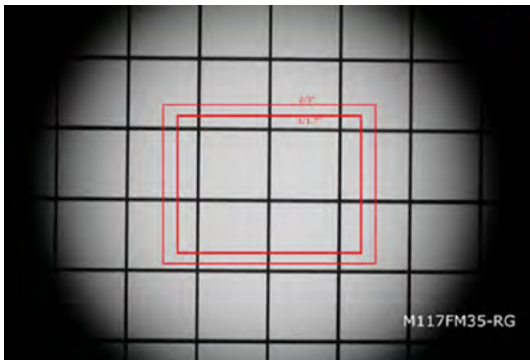

M117FM50-RG on an APS-C sensor

TAMRON

Focus on the Future

TAMRON Europe GmbH Industrial Optics Division

ROBERT BOSCH STRASSE 9 • D-50769 COLOGNE
PHONE +49 (0) 221 66 95 44-0 • FAX +49 (0) 221 66 95 44-404
MAIL cctv@tamron.de • WEB www.tamron.vision